

Hoesch isorock® vario

Installation recommendations

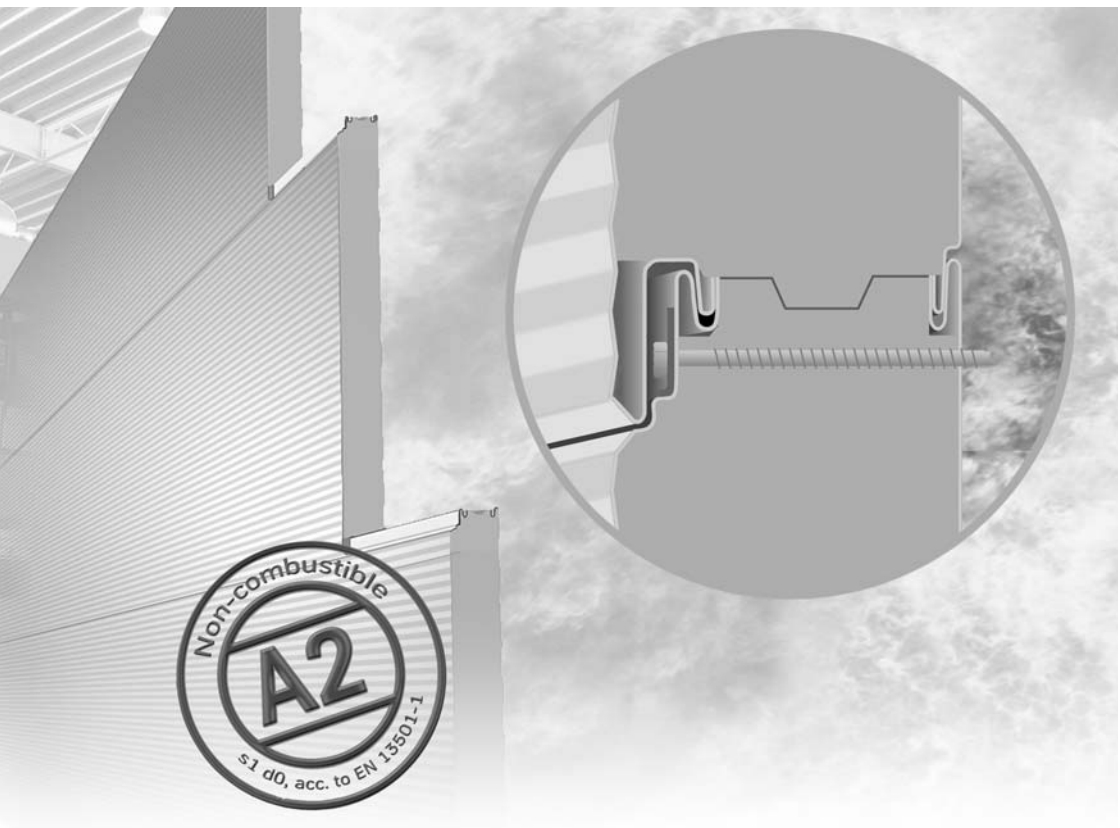

Table of contents

	Page
1. Regulations / Directives	2
2. Delivery / Unloading	3
3. Storage on the site	4
4. Preparation for installation	4
5. Protective foil (PF)	5
6. Cutting on site	5
7. Installation	6
7.1 How to order	7
7.2 Aligning / Checking	8
8. Fastening	9
9. Design details	10
10. Other matters	10

Hoesch isorock® vario

Installation recommendations

You have decided in favour of a product from our Hoesch isorock® range, i.e. for a high-quality industrially fabricated product. Thank you very much! In order to ensure that after completion of the production process, the product will be treated with the same care as in our company, we would like to inform you about the following mandatory handling procedures:

1. Regulations / Directives

Among other things, the following must be noted:

- General official approval no. Z-10.4-235, isorock®
- General official test certificate P - SAC 02/III - 096
- This item of technical information Hoesch isorock® vario
- Accident prevention regulations issued by the employers' liability insurance associations
- Directive for the installation of profiled steel sheets for roof, wall and floor decking issued by IFBS, information no. 8.01
- Information in the structural analysis and in the laying plans relating to the project

Installation recommendations

2. Delivery / Unloading

Please check the Hoesch isorock® vario packages on their arrival on site. Any complaints and any evidence of damage must be recorded on the shipping documents and reported without delay to the appropriate ThyssenKrupp Bausysteme sales office.

Complaints related to visible damage which are submitted later will not be considered.

Unloading and transport of the packages must be carried out singly i.e. one at a time.

Never unload two or more packages at the same time (pictures 1 and 3)!

When using a fork lift truck for unloading, the forks must take up the package below the two central styropor pallets (centre distance 980 mm) (picture 2). The maximum package length is 8m for this method of unloading; otherwise a fork extension with an additional fork arm must be used.

When using a crane for unloading, a spreader bar as well as suitable, sufficiently dimensioned lifting slings (no ropes or chains) should be used. Make sure that the panel edges are well protected (picture 4).

Fasten the slings to the spreader bar so that they hang vertically and can be pulled through the two supplied unloading aids (50 mm x 300 mm x 1060 mm) (picture 5).

Place the unloading aids between the styropor pallets, the protective surfaces being on the sides towards the Hoesch isorock® vario package.

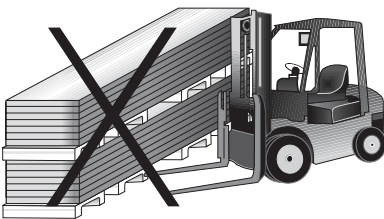

1

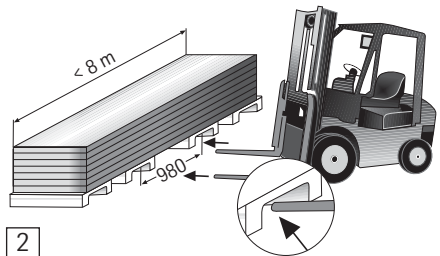

2

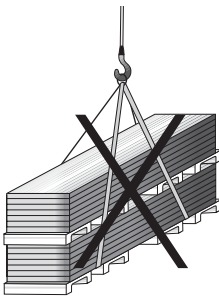

3

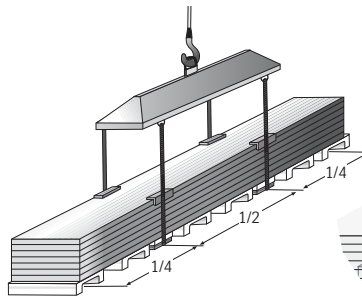

4

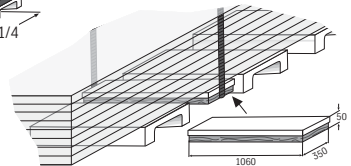

5

Installation recommendations

3. Storage on the site

Store the Hoesch isorock® vario panels on a firm, dry and clean base. When the panels are stored outdoors, make sure that they are protected against rain, storms and dirt. The formation of condensate must be avoided.

Make sure that the packages are stored in a slightly inclined position in order to allow any water that may have entered the package to drain out (picture 6).

When Hoesch isorock® vario packages are stored for an extended period of time on site they should be protected by a textile cover and/or stored in a place where they are protected against direct weathering (e.g. under canopies or inside dry buildings) (picture 7). Do not pile the packages one on top of another (picture 8) and do not store them on panels which have been installed already (e.g. on the roof). Secure any packages which have already been opened.

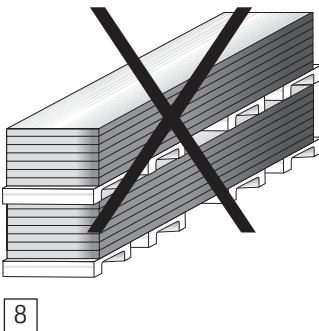
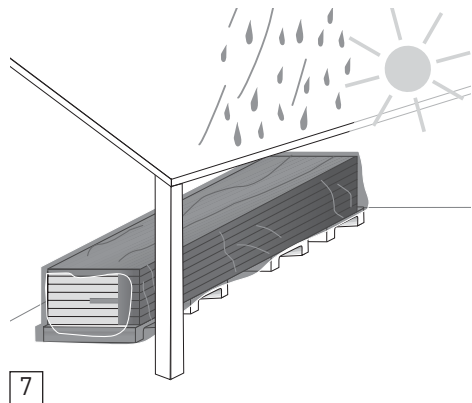
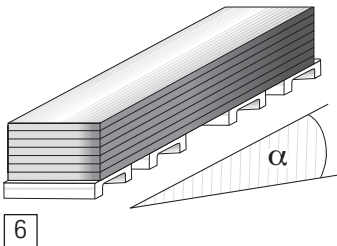

4. Preparation for installation work

Before commencing installation work, the supporting structure must be checked that it is suitable for the installation. Any defects must be reported to the works supervisor, in accordance with VOB. The necessary supporting widths must be determined on the basis of the structural analysis and the laying plans relating to the project.

Installation recommendations

5. Protective foil (PF)

Structural members provided with protective foil must be installed immediately, taking the following into account: The protective foil must be protected against UV radiation. It must be pulled off during installation work but not later than six weeks after delivery of the panels to the site (picture 9). In overlapping areas the protective foil must be removed before commencing installation work.

6. Cutting on site

Only use suitable cutting tools, e.g. a compass saw with fine teeth for the panels, plate shears and a nibbler for flashings (picture 10).

Any chips must be removed immediately.

Thermal cutting processes (e.g. abrasive cutting machines) must not be used. The "Hoesch isotrim®" cutting tool has proved to be well suited for carrying out cuttings on site. It can be ordered from ThyssenKrupp Bausysteme (part no. Z00-011) (picture 11).

Any cut-outs in panels prepared before the panels are installed must be reinforced appropriately for transport on site.

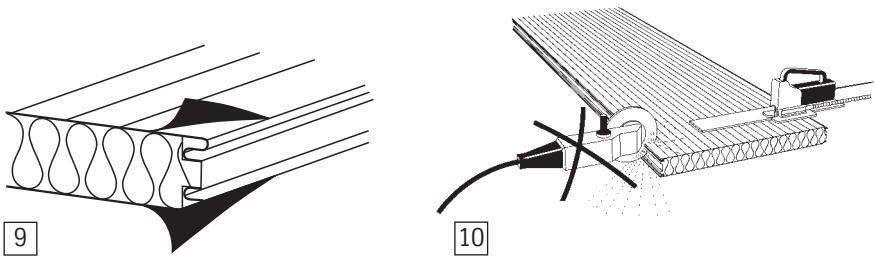

Installation recommendations

7. Installation

In order to ensure that installation takes place without any problems it is recommended that the following tools are used and the following order of work is observed.

For lifting and positioning the panels, it is recommended that a screw clamp is used (picture 12). ThyssenKrupp Bausysteme GmbH will provide these screw clamps against payment of a deposit (part no. Z43-171.0). In the case of horizontal installation, it is recommended that at least two clamps are used (picture 13). For long elements, a spreader bar should be used.

The lifting devices must be secured against accidental undoing (e.g. by slip-resistant rubber pads or by an additional lanyard).

When vacuum cups are used which keep panels in place by suctional force, ensure that such devices are suitable for use with mineral wool sandwich panels. For more information, please contact the manufacturer of these devices. Incorrect use or unsuitable devices may cause damage to the Hoesch isorock® vario element, especially when these devices are used on cover sheets with a flat surface (type E).

When removing single panels from a package, make sure that any deformation, deflection and localised loads on the panels are avoided! The panels should be transported vertically (pictures 14 A+B)!



12

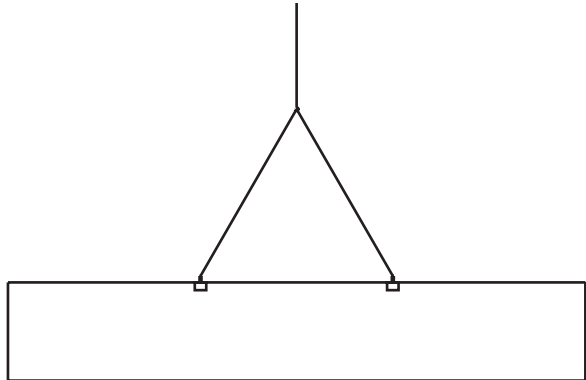

13

Installation recommendations

7.1 How to order

Normally, the panels are delivered packaged with their inside (B side) up. Only the lowermost panel is packaged with its outside up (A side). For many years, this procedure has worked well for transport and handling on site.

If otherwise required for installation reasons, please state on the order "A side up". This will ensure that the panels are packed accordingly with the exception of the uppermost panel which is packaged with its B side up, in order to protect the topmost A side.

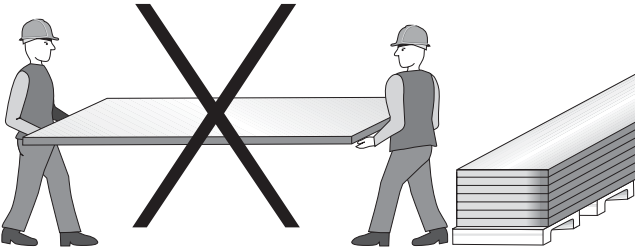

14 A

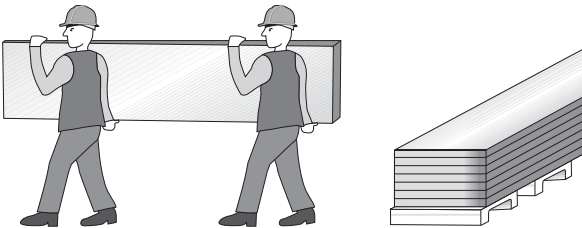

14 B

Installation recommendations

7.2 Aligning / Checking

The first panel must be exactly aligned and fastened, independent of the laying direction (vertical, horizontal, diagonal). It is not possible to correct the position of the subsequent panels by realigning the longitudinal joint (picture 15).

The longitudinal joints of the panels are provided with factory-inserted sealing tapes. Tight sealing is only ensured when observing the correct cover width (standard: 1000 mm) (picture 16). For checking the cover width, control marks spaced between 5 and 10 m should be provided on the supporting structure. For correct and expert installation, we recommend the use of pressing-on devices provided by ThyssenKrupp Bausysteme (part no. Z 43-114) as an installation aid (picture 18). Using these devices, modular dimensions can be easily and exactly adhered to, and the required pressing-on force for achieving tight seals can be precisely adjusted. The number of devices required (at least 2) depends on the length of the panels.

Please note:

Individuals are allowed to walk on the Hoesch isorock® panels for installation purposes but the panels should not be misused as an installation platform or a base for the storage of materials from any other trade.

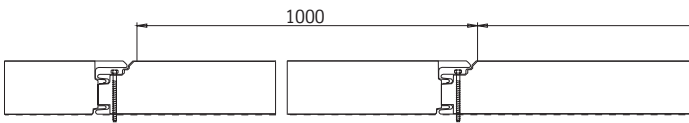

15

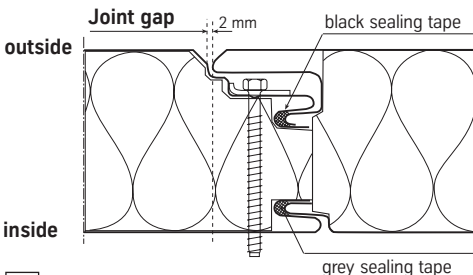

16

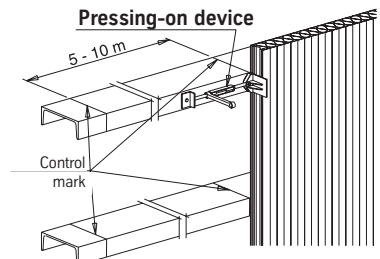

17

Installation recommendations

8. Fastening

Hoesch isorock® panels are fastened in the longitudinal joint using the concealed fastening method.

Depending on the structural requirements, the elements are fastened to the supporting structure with or without a load distribution plate (part no. Z43-141.0) (picture 18).

For fastening the panels, only use officially approved stainless steel fasteners. For the type of bolt, the number of bolts, their size and their spacing, please see the installation plan. The installation plan is based on the project-related structural analysis and the Hoesch isorock® approval Z-10.4-235. In the case of panels classified as fire-resistant (DIN 4102-2, 3), the installation plan is based on the official test certificate P-SAC 02/III-096. The correct length of the screws can be determined as shown in picture 18.

Make sure that the cover sheet is not indented by excessive tightening of the bolts. It is recommended that so-called "façade bolts" with supporting thread under the head are used.

It is recommended that electric drills with a bit stop are used. Any drilling chips must be removed immediately. In order to ensure correct positioning of the fasteners, an auxiliary groove is provided on the tongue side of the panel (picture 19).

without load distribution plate

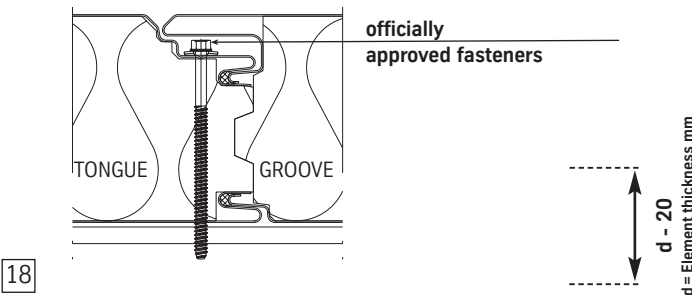

with load distribution plate

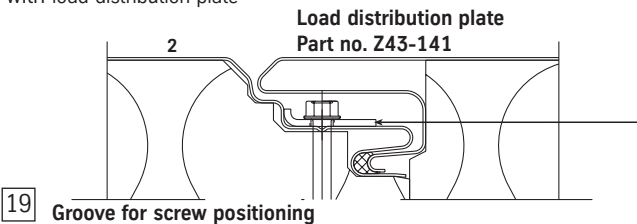

Installation recommendations

9. Design details

Proposed design details for foot points, roof connections etc. may be downloaded from our homepage www.tks-bau.com.

10. Other matters

These installation recommendations are based on many years of experience by us and our customers. They have been prepared to the best of our knowledge. The latest version of our technical documentation and also these installation recommendations can be found on our homepage www.tks-bau.com.

If the above procedures are not observed, any right to make a complaint in the event of damage will be inadmissible.

Observance of the recommendations does not release the user of our products from his obligation of complying with the local situation and circumstances.

ThyssenKrupp Bausysteme GmbH

Hammerstraße 11

D-57223 Kreuztal

Phone + 49 / 27 32 / 599 1 221

Fax + 49 / 27 32 / 599 1 219

E-Mail: info@tk-bau.thyssenkrupp.com

Internet: www.tks-bau.com



The information contained herein defines assured properties only when they are individually confirmed in writing. Subject to modification.
GB • Info 2.4.2 • 7.2007 • bc